



SC Series

SC Secure Lockable Connector

Features:

- Ideal for networks with higher security levels such as military, government and financial;
- Five different colors/keys available;
- Can only be removed with matching color key;
- Applies to 2.0/3.0mm cable;
- FOCIS-3/ TIA-604-3 and GR326-core compliant;
- RoHS /REACH and UL94-V0 inflammability grade compliant.
- Compatible with all industry standard SC adapters

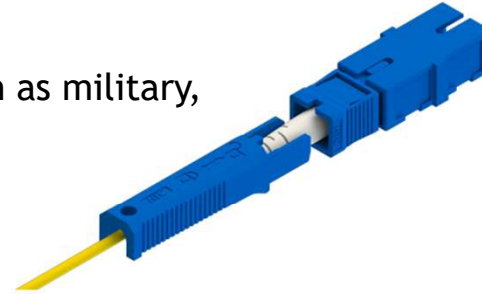

SC Secure Lockable Connector

Higher Security Locker Key:

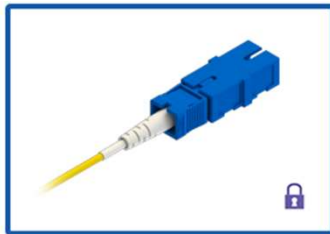

① Locked

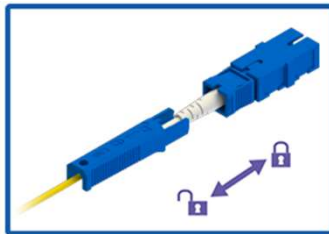

② Insert matching tool

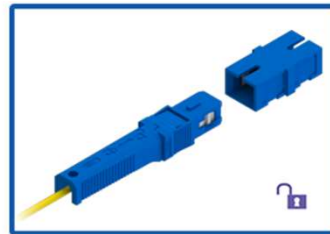

③ Unlock and remove connector

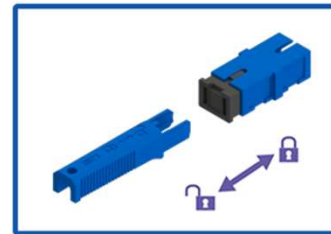

④ The dust cap only can be extracted by keys.



SC Series

SC Secure Lockable Connector

Specification:

Items	Single Mode		Multi Mode
Connector Type	UPC	APC	PC
Insertion Loss	≤0.3dB		≤0.3dB
Return Loss	≥50dB(UPC);	≥60dB(APC)	≥30dB
Durability Test	100 times		
Operation Temperature	-40°C ~ +85°C		

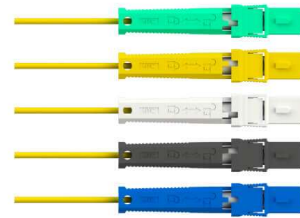
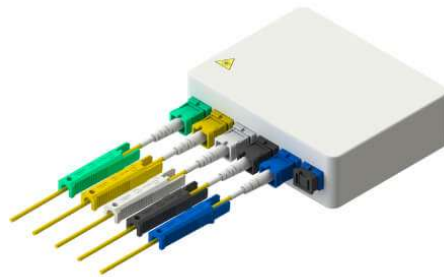

SC Secure Lockable Connector Mechanical Drawing

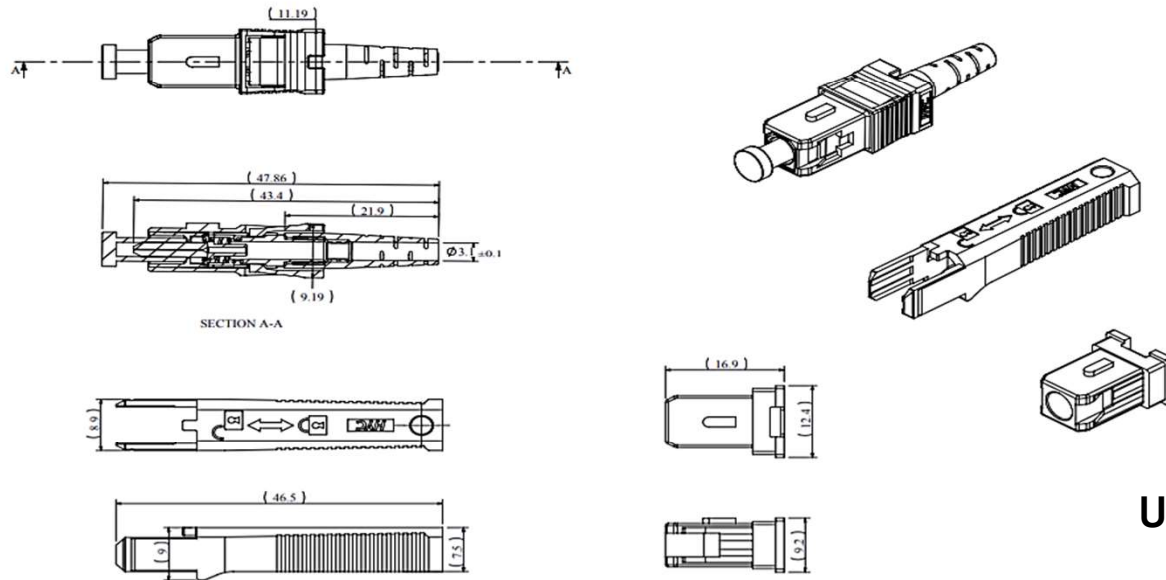

Unit: mm